

Positioning, Navigation, and Timing (PNT) Integrated Mission Delta (IMD)

21 November 2023



Ms. Barbara Baker
Deputy Program Executive Officer
MilComm & PNT Program Executive Office



- IMD Way-Ahead / Expected Outcome
- Challenge / Solution
- Service-Level View
- Organization Structure
- Summary
- Questions



“Now we must focus our efforts on a purpose-built Space Force for great power competition.”

- Chief of Space Operations, General B. Chance Saltzman



Unified Mission Readiness (UMR) will strengthen unity of command for readiness and energize unity of effort for capability development by organizing U.S. Space Force activities around mission areas rather than functional specialties

To achieve UMR, the U.S. Space Force will prototype two new types of Deltas:
Integrated Mission Deltas (IMDs) for readiness and
System Deltas (SYDs) for capability development

IMD's Expected Outcomes

- Unity of Command for mission readiness
- Accountability aligned for full-spectrum readiness
- Leadership and career path agility
- Tighter coupling of MX & enhancement w/ ops needs



A Collection of Tactical Activities?

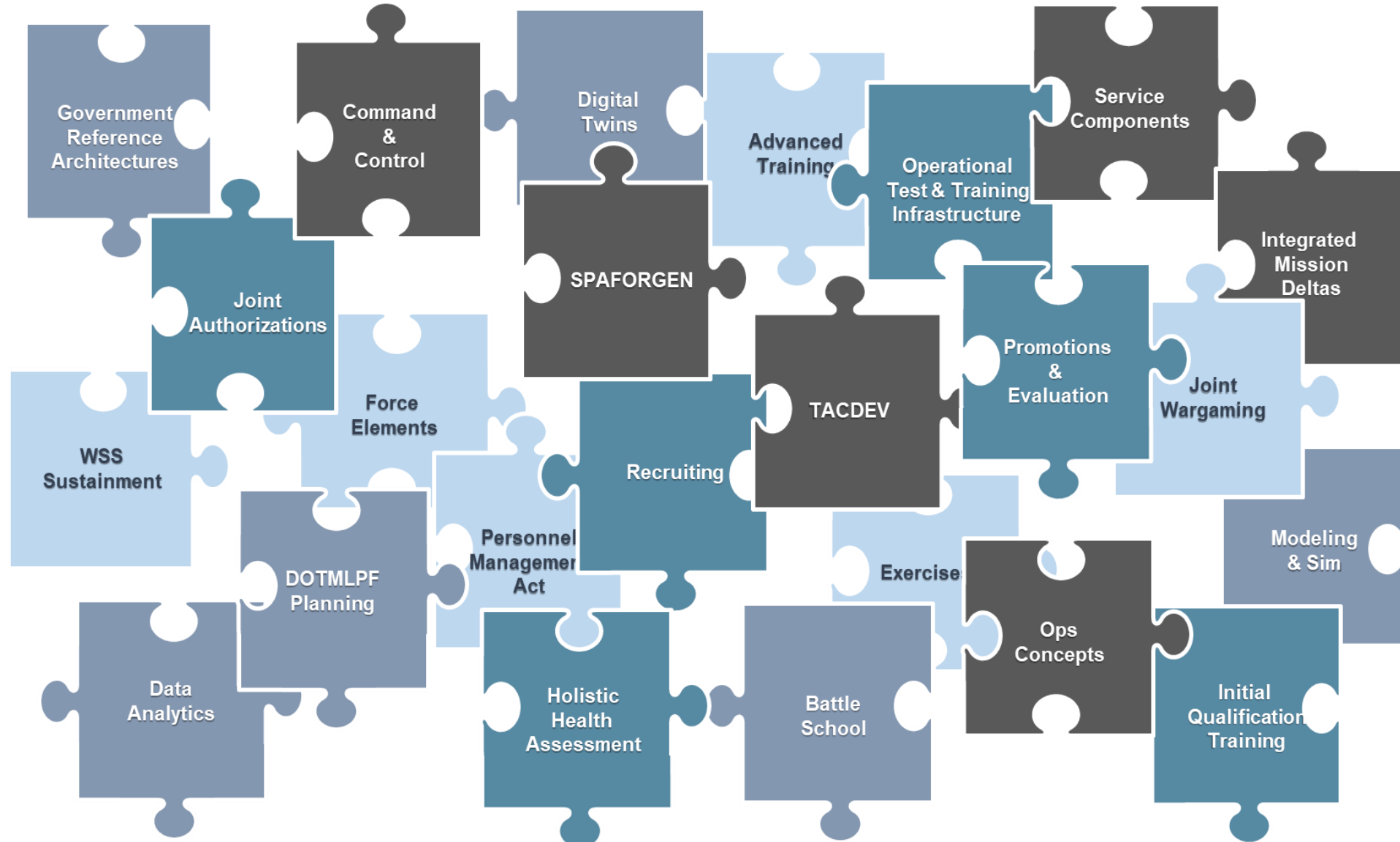

#SpaceStartsHere



...or Building an Independent Service

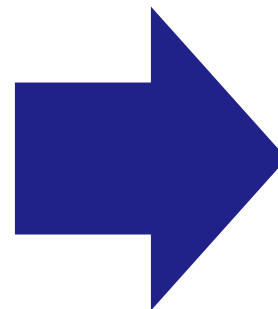
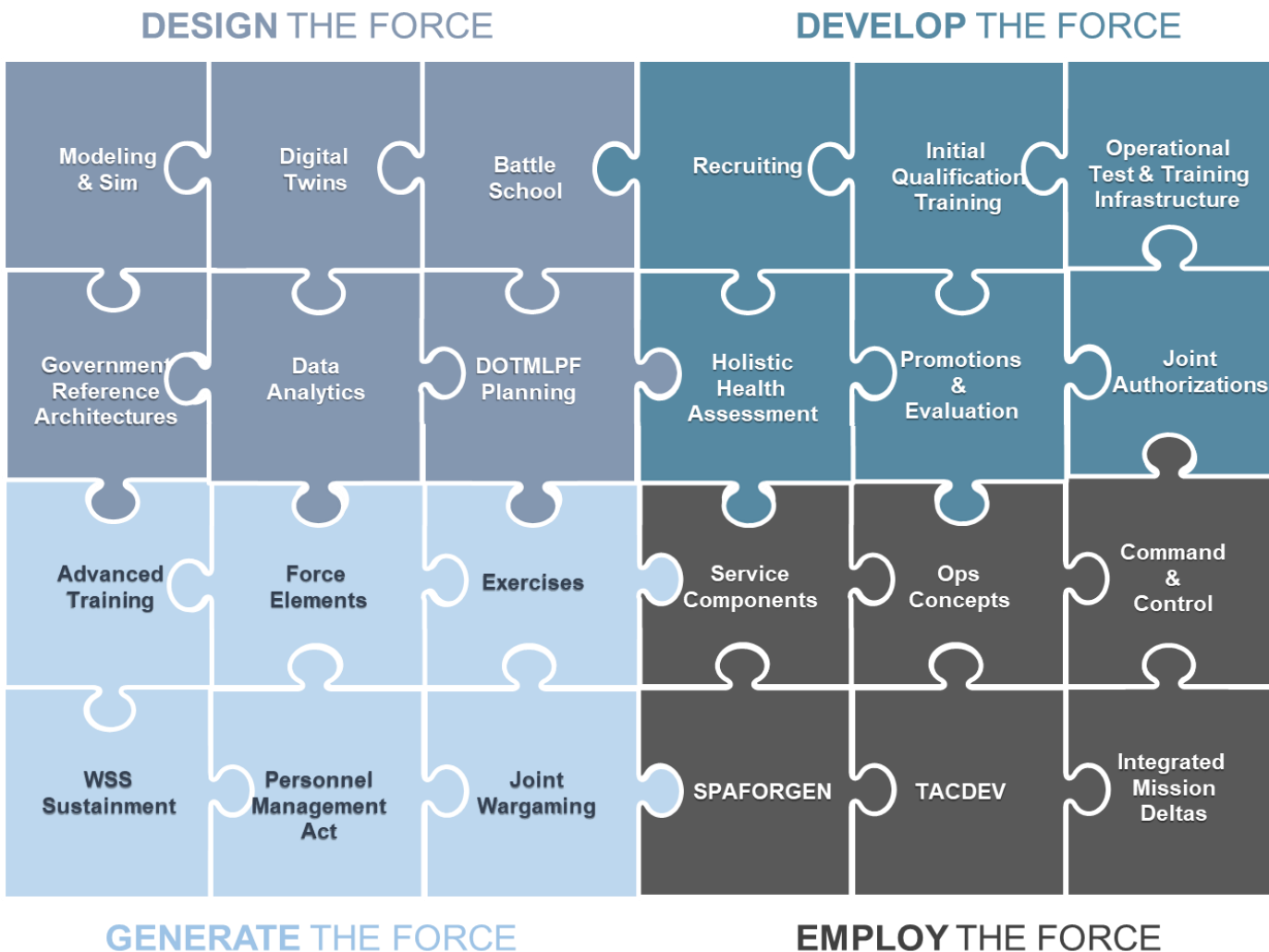

Our Goal:
Combat Ready Forces
For the Joint Fight



Today's Functional Alignment Challenge

Field Command

Delta

Functions

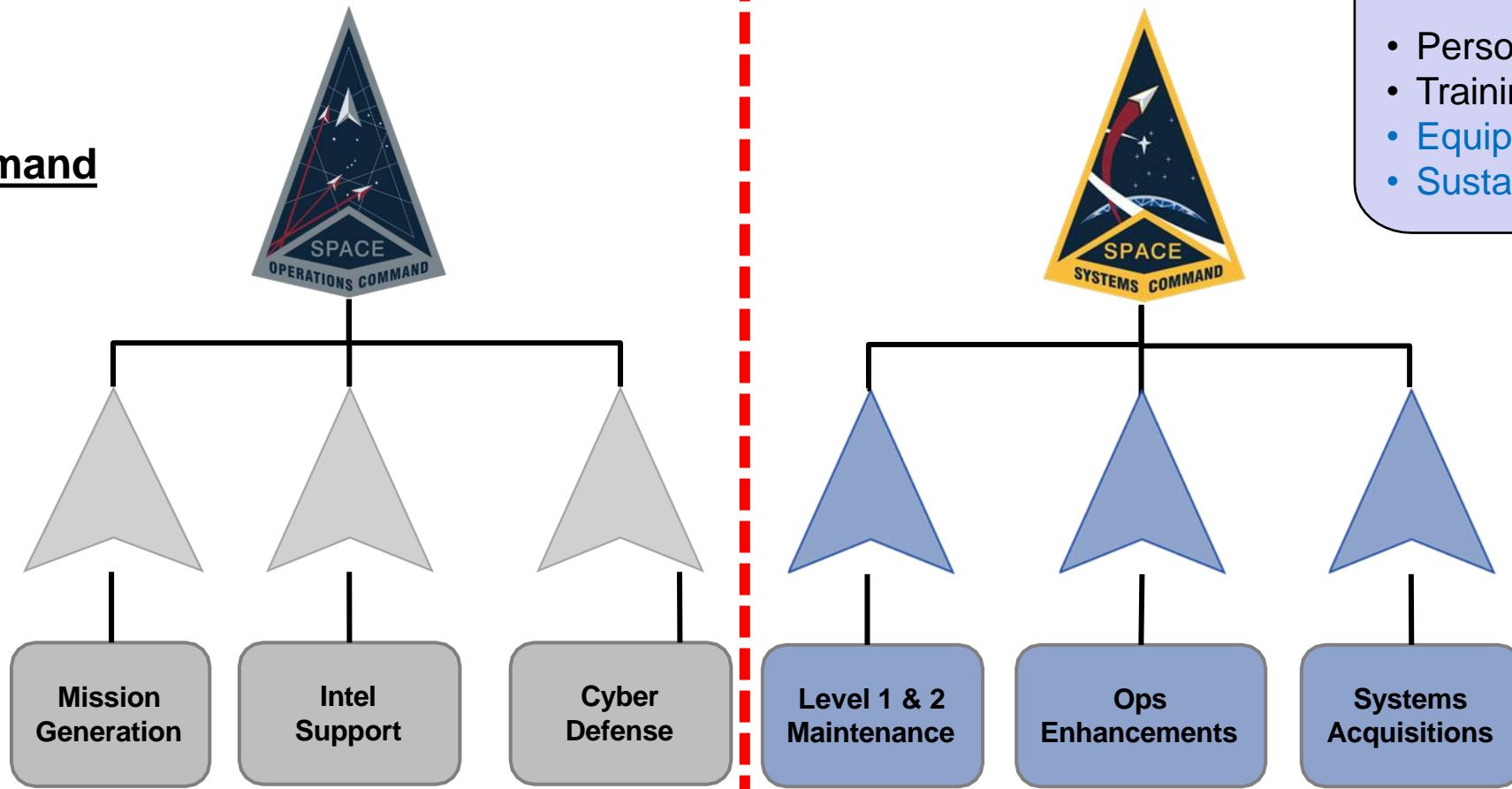

Readiness Elements

- Personnel (SpOC managed)
- Training (SpOC managed)
- Equipment (SSC managed)
- Sustainment (SSC managed)



Integrated Mission Delta

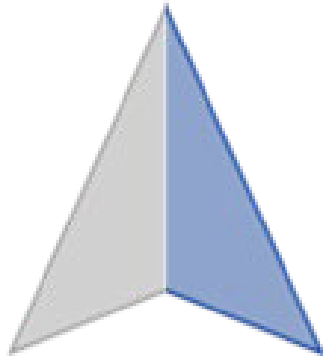

Functions: Generate, Maintain, Enhance

Activities: Force generation, combat training, intelligence support, cyber defense, preventive maintenance, anomaly resolution, operations enhancements, mission planning tools

System Delta



Functions: Design, Develop, Deliver

Activities: Requirements development, source selection, tech maturation, risk reduction, engineering design and development, assembly, integration, test, systems acquisitions, block upgrades, new capabilities



Expected Outcomes

- Unity of Command for mission readiness
- Accountability aligned for full-spectrum readiness
- Leadership and career path agility
- Tighter coupling of MX & enhancement w/ ops needs

- Organized around single mission area
- Composite command team
- *Any specialty can command*

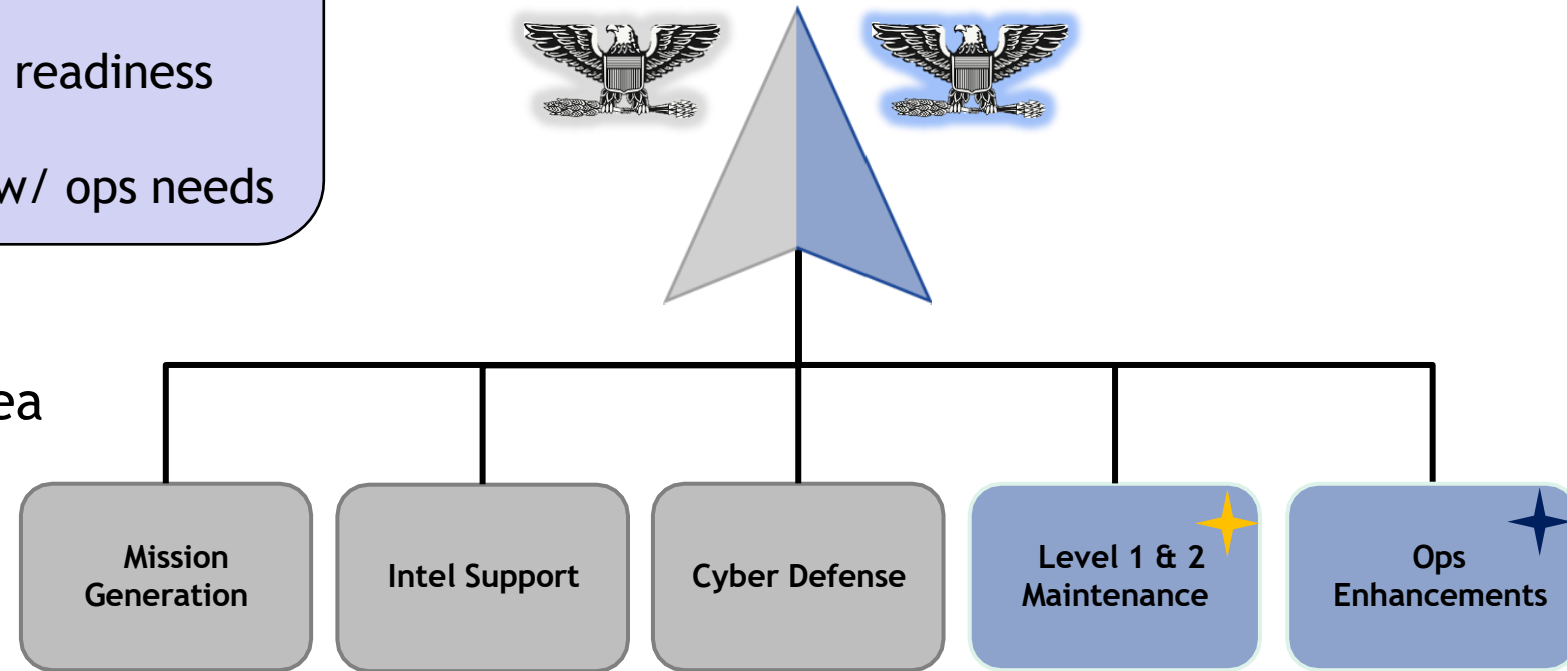

✦ *Including product support manager and contractor logistics lead* ✦

✦ *For example, agile software upgrades and tool development* ✦



Service Level View

- Chain of acquisition authorities unchanged (SAE □ PEO □ PM)
- Establishes System Deltas to align w/ IMDs in shared mission area – unity of effort across Service
- Rebalances workload across FLDCOMs in advance of USSPACEFOR-SPACE
- Preserves integrity of FLDCOM Staffs

- IMDs blend Force Gen w/ Level 1 & 2 MX and Ops Enhancements under SpOC
- System Deltas continue to perform System Acquisitions under SSC

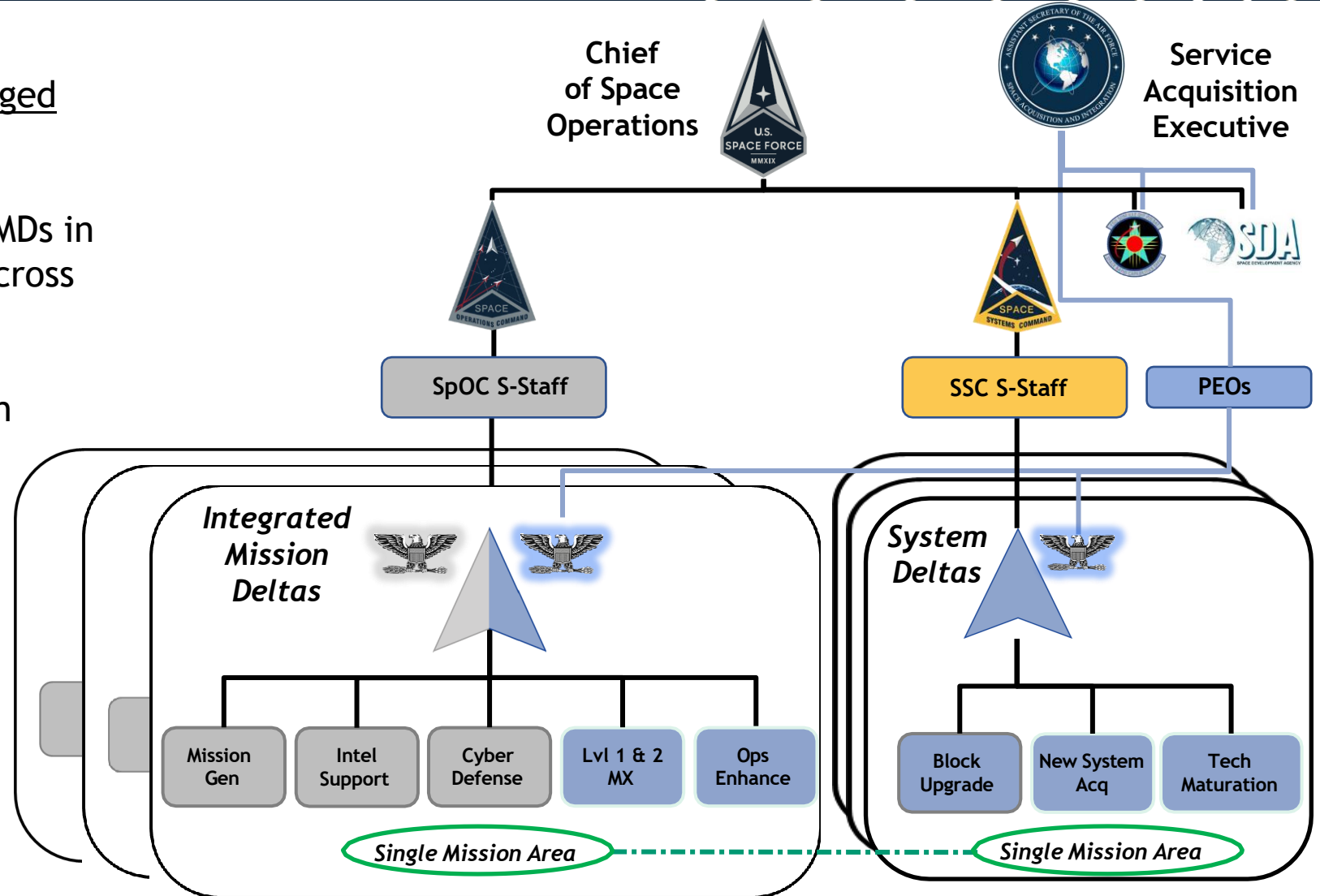



PNT Delta (Provisional)

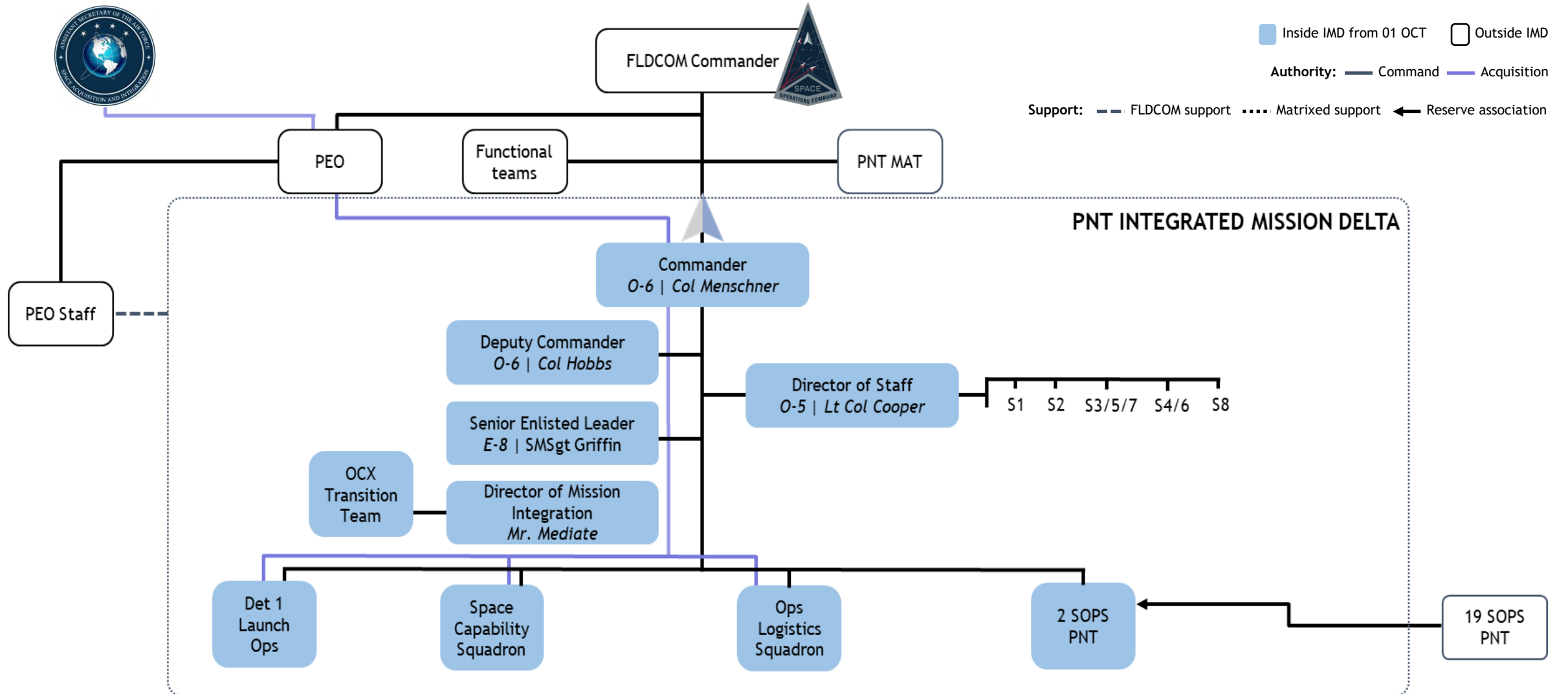

#SpaceStartsHere



Integrated Mission Delta



Achieve **unity of command** for all aspects of mission readiness and **unity of effort** in capability development activities



Integrate Guardians with diverse expertise under a single organizational construct to facilitate **rapid design, test, fielding, and sustainment**, yet still protects future long-term capability development



Provide **commanders responsibility and authority** over all aspects of their **assigned personnel and weapons systems** to ensure **sufficient readiness** to meet combatant commander needs



Create an organizational construct that **aligns with joint doctrine**, fully enables the **SPAFORGEN** rotational construct, and distinguishes between assigned, retained, and institutional forces



Allow CSSB-vetted officers from **any career field** (13S, 14N, 17D, 62E, or 63A) to be **IMD/CCs**



Questions?



Leadership Team



Mr. Cordell DeLaPena, Jr.
Program Executive Officer



Ms. Barbara Baker
Deputy Program Executive Officer



Col Matthew Flahive
Deputy Director



Lt Col Marsha Goetz-Browning
Chief of Staff



Col Andrew Menschner
PNT Delta (P) Commander



Mr. George Gonzales
Director SATCOM Sustainment



Ms. Charlotte Gerhart
Acq Delta – Tactical SATCOM



Col Albert 'AJ' Ashby
Acq Delta – Strategic SATCOM



CAPT Peter Sheehy
Acq Delta- Narrowband SATCOM



Col Matthew Spencer
PNT SYD



Mr. Marcus McInnis
Director of Engineering



Mr. Lucas Sprenger
Director of Finance



Mr. Dennis Higuera
Director of Acq Logistics



Mr. John Travera
Director of Mission Services



Mr. Roy Lee
Director of Contracts



Col Heather Anderson
Director of Transition